

GO -06-19-28-AC-ECP  
GO -06-19-50-AC-ST  
GO -06-19-50-AC-STB  
GO -10-19-28-AC-ECP  
GO -10-19-50-AC-ST



## GABINETE DE POSTE PARA EXTERIORES



- Estructura de acero 100% galvanizado
- Compacto
- Protección de equipos



Distribuido en Perú por:

**COMUtel**

**MATERIAL**

Acero galvanizado minimizado AISI -1020.

**SUPERFICIE**

Pintura electrostática en polvo epoxi.

Resistencia a la corrosión, manchas y productos químicos. Resiste altas y bajas temperaturas, rayos UV y humedad. Resistencia al impacto.

Rieles galvanizados.

**VOLUMEN DE SUMINISTRO**

Diseñado de acuerdo con la norma IEC 6297-3-100. Dimensiones y estructura mecánica de serie 482,6 mm (19").

Producto para ambientes exteriores, con sistema automotriz de sellado en su puerta.

Modelos con y sin compartimento para pilas.

Tiene fijación versátil y puede instalarse en postes mediante abrazadera tipo fleje de acero (no incluida) o también atornillarse a superficies planas, como paredes.

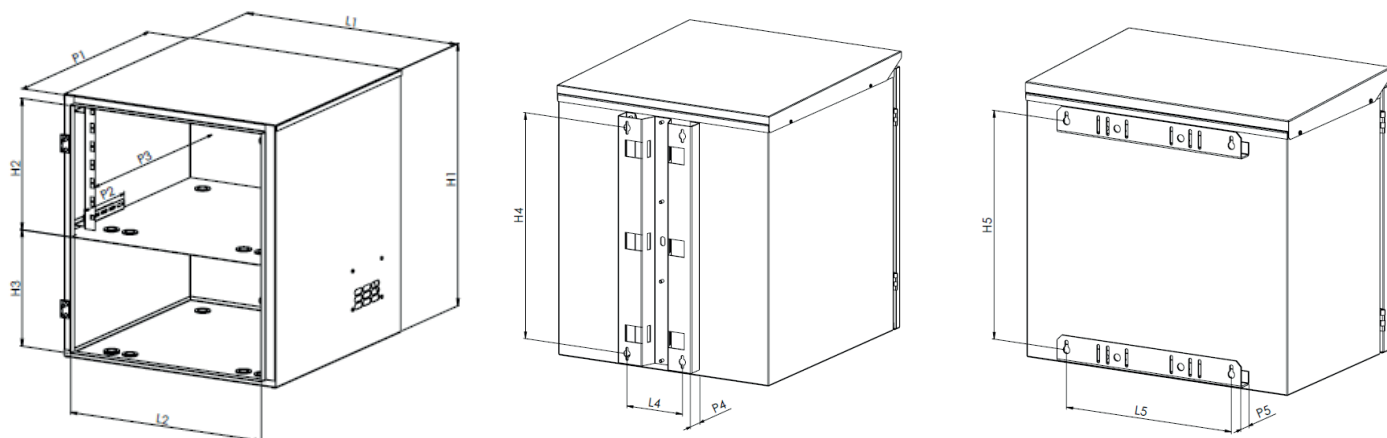

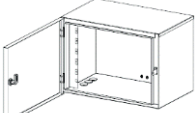
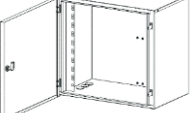
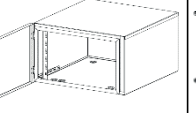
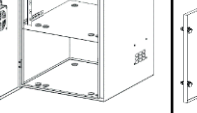
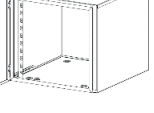
					
	GO-06-19-28-AC-ECP	GO-10-19-28-AC-ECP	GO-06-19-50-AC-ST	GO-06-19-50-AC-STB	GO-10-19-50-AC-ST
Fixação	Poste	Poste	Poste	Poste/Parede	Poste
Altura (H1)	323mm	503mm	335mm	635mm	515mm
Profundidade do corpo (P1)	340mm	340mm	590mm	590mm	590mm
Largura do corpo (L 1)	555mm	555mm	570mm	570mm	570mm
Altura útil do co mpartimento de equipamentos (H2)	320mm	500mm	330mm	335mm	510mm
Altura útil do co mpartimento de baterias (H3)	-	-	-	295mm	-
Profundidade d e ajuste do trilho (P2)	Trilho Fixo	Trilho Fixo	175mm	175mm	175mm
Profundidade interna útil (P3)	260mm	260mm	545mm	545mm	545mm
Largura interna da porta (L 2)	490mm	490mm	510mm	510mm	510mm
Distância entre furos vertical (H4)	-	-	-	550mm	-
Distância entre furos horizontal (L4)	-	-	-	150mm	-
Profundidade do suporte (P4)	-	-	-	45mm	-
Distância entre furos vertical (H5)	260mm	435mm	265mm	-	445mm
Distância entre furos horizontal (L5)	350mm	350mm	350mm	-	350mm
Profundidade do suporte (P5)	30mm	30mm	30mm	-	30mm
Ventilação	Opcional	Opcional	Opcional	Sim	Opcional
Volume interno	60L	94L	112L	194L	175L
Massa do gabinete	12kg	14kg	21kg	35kg	25kg
Massa com embalagem papelão	13kg	15kg	25kg	37,5kg	29,5kg
Massa com embalagem madeira	17,5kg	20kg	28,5kg	44kg	33kg
Dimensões da embalagem papelão (AxPxL)	0,41x0,45x0,60m	0,60x0,45x0,60m	0,42x0,63x0,71m	0,72x0,63x0,71m	0,60x0,63x0,71m
Dimensões da embalagem madeira (AxPxL)	0,55x0,48x0,68m	0,71x0,48x0,68m	0,53x0,72x0,70m	0,85x0,68x0,70m	0,72x0,72x0,70m

# ADICIONALES

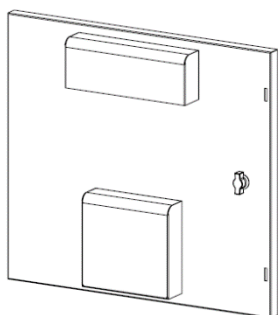

Ventilação\*

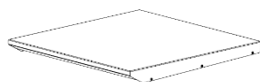

Chapéu



Bandeja

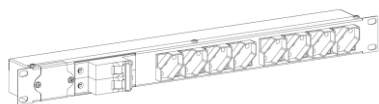

Régua Protetiva

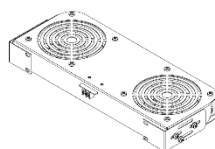

Ventilação Forçada\*\*



Organizador de Cabos\*\*

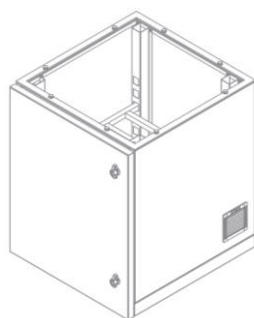

\*\*\*Compartimento para baterias *Standard*.  
*GB-61-55-55-AC*

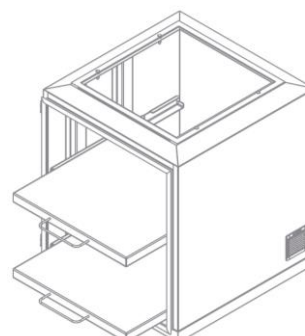

\*\*\*Compartimento para baterias *Heavy*.  
*GB-82-70-74-AC*

\* Somente para modelos GO-06-19-28-AC-ECP, GO-10-19-28-AC-ECP, GO-06-19-50-AC-ST, GO-10-19-50-AC-ST.

\*\* Recomendados apenas para os modelos GO-06-19-50-AC-STB, GO-06-19-50-AC-ST, GO-10-19-50-AC-ST.

\*\*\* Somente compatível com os modelos, GO-06-19-50-AC-ST, GO-10-19-50-AC-ST, GO-06-19-50-AC-STB.

✉ [ventas@comutelperu.com](mailto:ventas@comutelperu.com)

📞 (+511) 480 1010

📍 Calle Fray Angélico 145  
San Borja - Lima-Perú

[comutelperu.com](http://comutelperu.com)